

Servicing instructions

NOTE: When handling the magnets, care should be taken at all times to ensure they are not placed near another metallic/magnetic source. It is also important to keep the magnets dry at all times. If the magnet plate is removed, ensure water does not spill inside the magnet pockets. Ensure all O-rings are seated correctly in the grooves above each magnet pocket before magnet plate is re-inserted.

Follow the simple steps below when undertaking a service on the *MagnaClean* in-line filter:

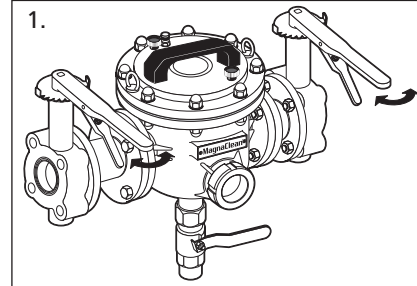

1. Check the *MagnaClean* sight glass for build-up of black iron oxide. If a service is required, turn off the boiler and isolate the electrics. Turn off the isolation valves on either side.

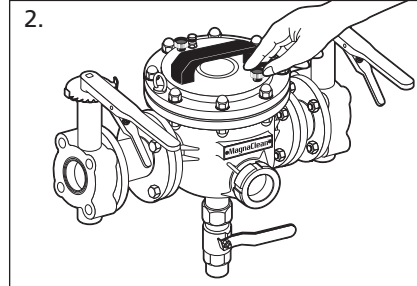

2. Unscrew the black retaining knobs on the removable magnet plate.

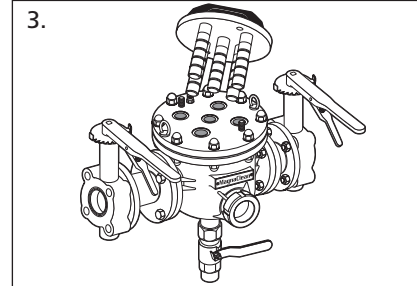

3. Using the handles, carefully lift out the magnet plate and remove from the stainless steel housing. Take care not to knock or drop the magnet plate as this can result in damage. Ensure the magnet plate, all magnets and magnet pockets remain dry at all times.

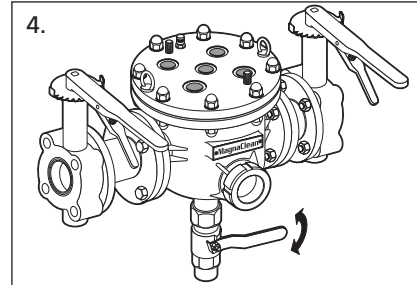

4. Connect hose to the 1/4" drain valve and open the valve or place a bucket underneath and remove the drain plug.

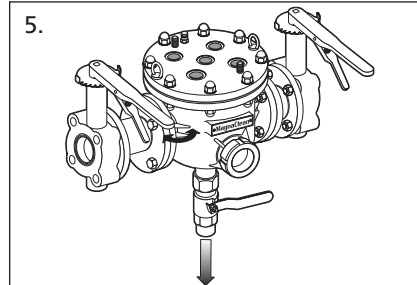

5. Slightly open the inlet isolation valve, leaving the other valve closed, and allow the deposits to drain through.

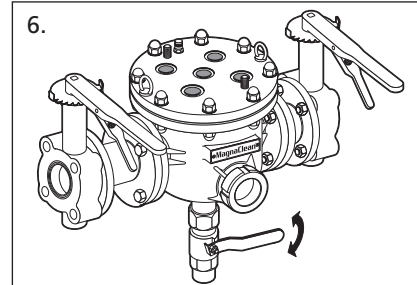

6. Once clean, close the inlet isolation valve, then close the drain point (i.e. turn off the drain valve or replace the plug.)

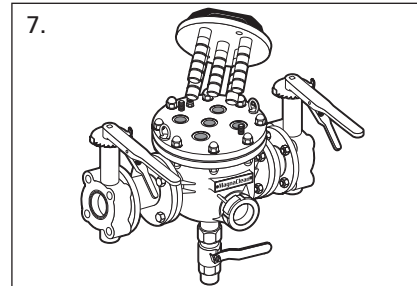

7. Before replacing the magnet plate, ensure the magnets and magnet pockets are moisture-free by drying them with a soft absorbent cloth. Ensure all O-rings are seated correctly in the grooves above each magnet pocket and free from damage. Grease the magnets with a silicone lubricant and insert the magnet plate so the magnets engage with the magnet pockets and the plate is returned to the home position.

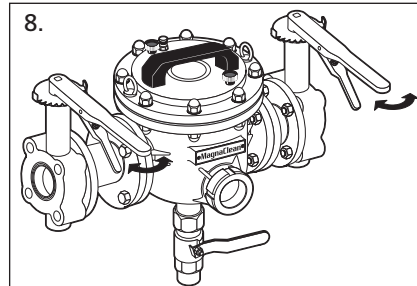

8. Secure black retaining knobs to ensure magnet plate is fixed. Hand tighten only. Re-open both isolation valves.

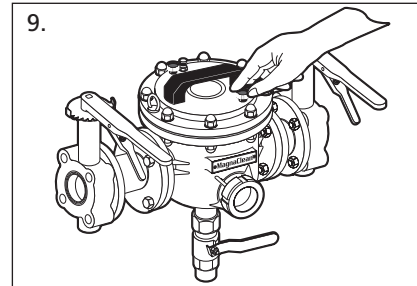

9. Bleed the air from the filter using the air vent. Ensure that the magnet pockets are closed to ingress of water vented during air removal process. Use a suitable method of closing magnet pockets during this process. E.g. use cloth to block pockets temporarily. Wipe off any excess fluid from housing plate.

(If O-rings are lost or damaged please contact ADEY Customer Services Team on 01242 546717 or visit www.adey.com to arrange replacements).

Energy saving thermal jacket

Designed to insulate the *MagnaClean Commercial* filter, retaining heat levels, thermal jackets reduce energy consumption, energy costs and carbon emissions. From the moment the thermal jacket is installed, significant benefits are delivered:

- Energy savings up to £60 year-on-year
- Reduced carbon emissions
- Protection against heat loss
- Frost protection
- Waterproof and suitable for all weather conditions

Thermal jacket product code	Description
CP1-03-01885	2" <i>MagnaClean Commercial</i> thermal jacket
CP1-03-01886	3" <i>MagnaClean Commercial</i> thermal jacket
CP1-03-01887	4" <i>MagnaClean Commercial</i> thermal jacket
CP1-03-01888	6" <i>MagnaClean Commercial</i> thermal jacket
CP1-03-02253	8" <i>MagnaClean Commercial</i> thermal jacket

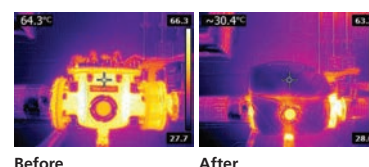

Before After

MagnaClean®

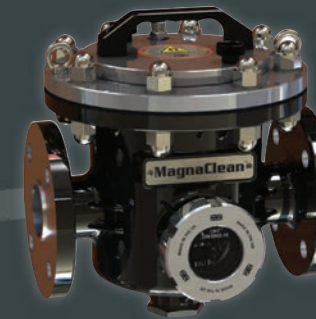

Technical specifications

MagnaClean

Maximum working pressure: 10 bar
Maximum working temperature: 100°C

Casing

Material: 304L stainless steel
Shape: Single inlet/outlet, 1/4" BSPP hole, 1/4" BSPT plug
Lid Seal: EPDM

Gaskets

Material: EPDM

Flow flange

Size: PN16

Magnets

Material: High power, NeFeB
Pocket sleeves: 304L Stainless steel

MagnaClean designed, manufactured and third party approved to EN 13445 : 2009

Inlet/outlet flanges

Size options: 2", 3", 4", 6", 8" Flanges: PN16 Standard

Filter size	Flange Thickness (mm)	Bolt size	Bolt quantity	Bolt hole PCD
2"	18	M16	4	125
3"	15	M16	8	160
4"	15	M16	8	180
6"	18	M20	8	240
8"	19	M20	12	295

Sight glass

Weld material: DIN1.4404 stainless steel
Collar nut: DIN1.4301/DIN1.4307 stainless steel
Glass: Toughened soda lime to BS3463
Product side seal: EPDM
Outer seal: Non-asbestos fibre (KILINGERSil C-4400)

Product code	Filter diameter (mm)	Inlet size (mm)	No. of magnetic rods	Flow rate – cubic m3/hr	Casing volume (litres)
CP1-03-01123	160	50	5	64	3.3
CP1-03-01124	210	80	6	100	7.08
CP1-03-01125	216	100	7	102	8.18
CP1-03-01126	324	150	9	108	26.37
CP1-03-02147	324	200	9	112	30.7

Service warranty

The product is backed by a two year warranty.

These installation and servicing instructions apply to both *MagnaClean Commercial* and *MagnaClean Industrial*.

Call our customer service team on 01242 546717 for more information.

For the most up-to-date version of installation and servicing instructions visit www.adey.com



ADEY
PROFESSIONAL HEATING SOLUTIONS

Telephone: 01242 546717 Email: info@adey.com
www.adey.com

A carbon neutral company

© ADEY Commercial LLP (RN OC382096)

*MagnaClean®, MagnaClean Commercial® and any associated logos are trademarks of ADEY Holdings (2008) Limited (RN 06738605) Patents apply (ADEY Industrial): United Kingdom: GB2402894 Europe (Netherlands, Germany, Italy, France, Ireland, Belgium, Austria): EP1626809 USA: US3443983 and US7726492

MagnaClean®

Installation and servicing

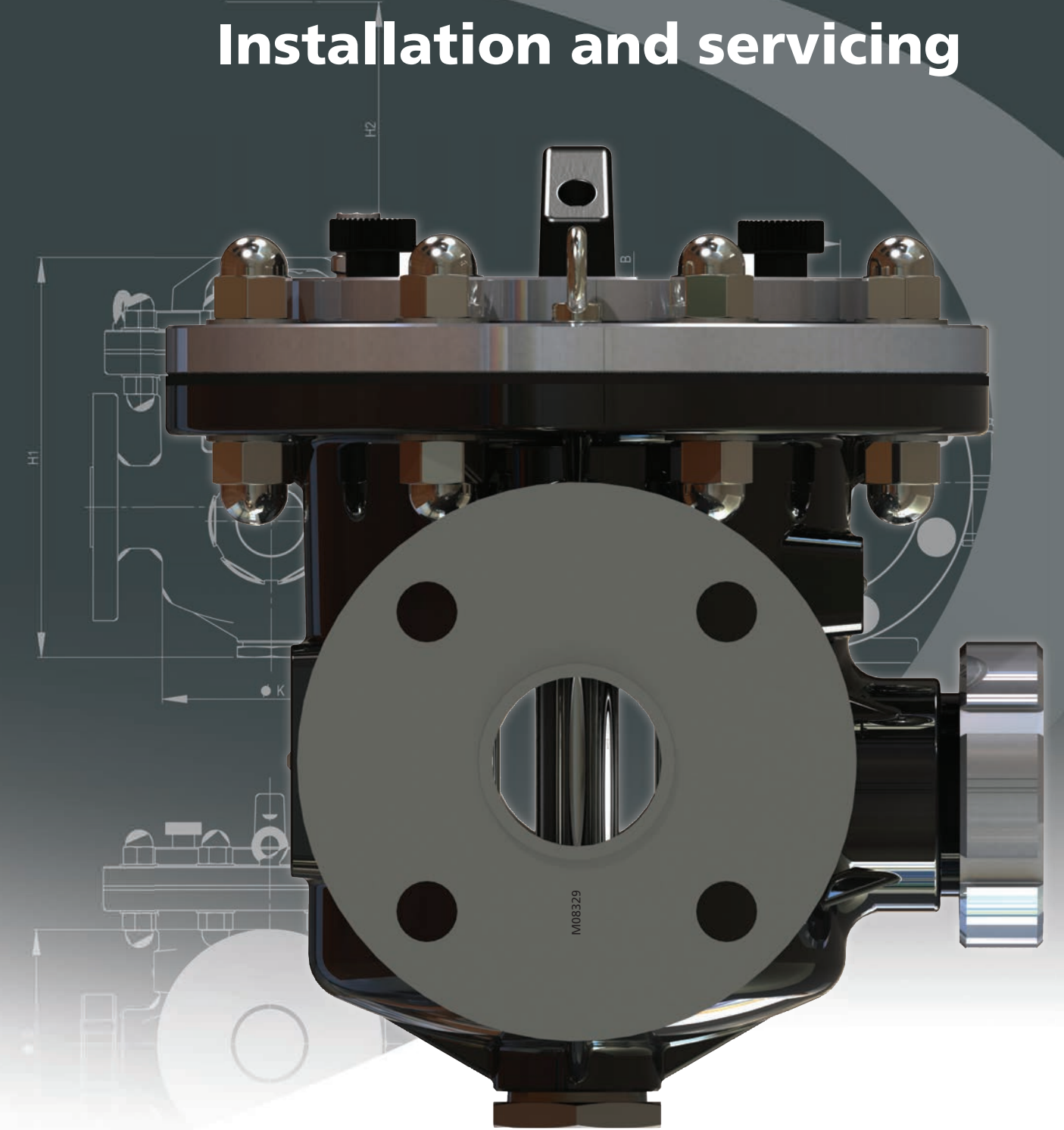

ADEY
PROFESSIONAL HEATING SOLUTIONS



Installation instructions

MagnaClean® Commercial is an incredibly powerful range of magnetic filters designed to remove magnetite from light commercial heating systems through to heavy industrial applications.

The exceptional design characteristics and high production quality of *MagnaClean Commercial* make installation and ongoing maintenance extremely straightforward.

Correct installation and servicing is essential to ensure optimum operating performance and a longer operational life for the system.

Flexible magnetic filtration options

As can be seen in the diagram below, *MagnaClean Commercial* provides a number of installation solutions in terms of unit size and location. The typical HVAC system illustrated identifies two of these options within the various circuits.

Installation with Cascade (zoned) system

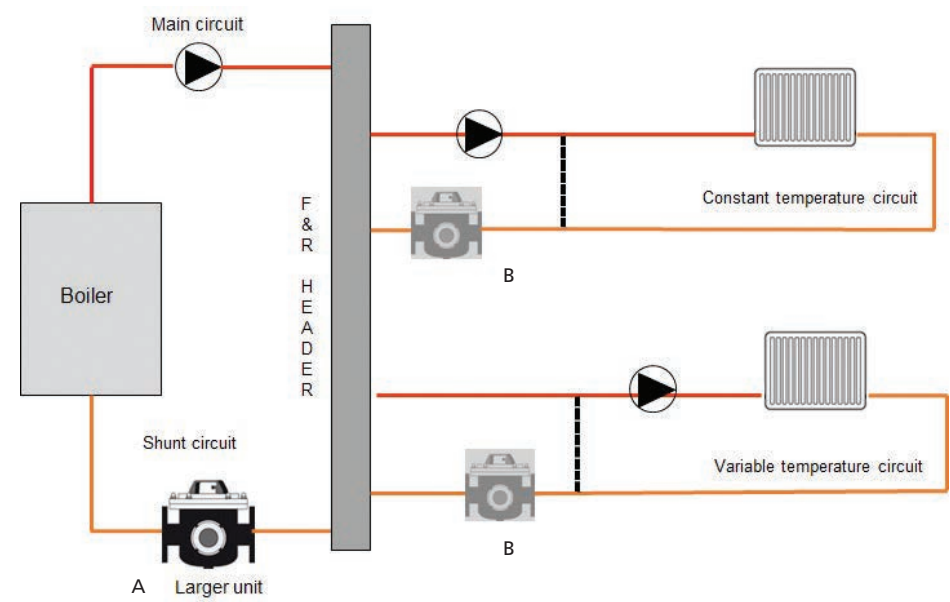

* Position A is the recommended best practise installation option. Position B could be added in as an option to further protect the system.

Installation with a Low loss header

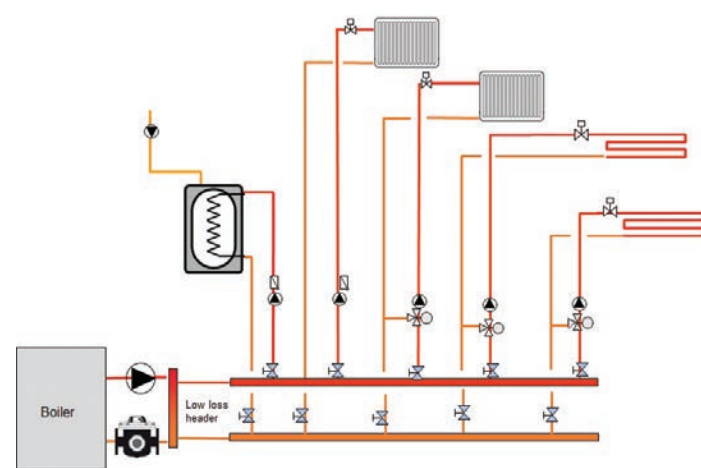

Installation with a Plate to plate

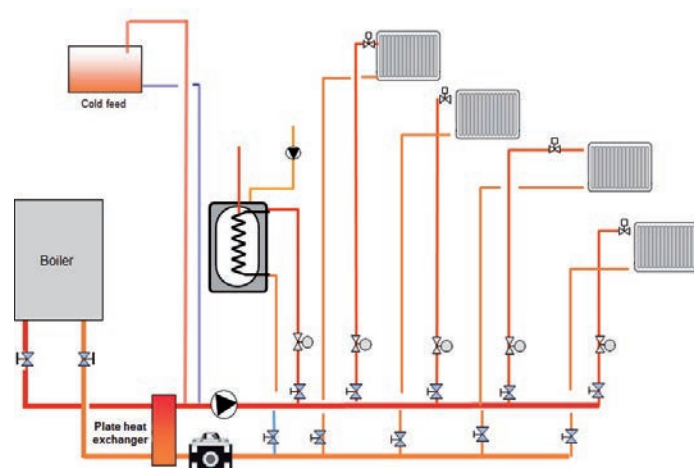

For chiller systems, it is recommended that a *MagnaClean* is installed on the return of the system before the chiller.

Pressure differential flow

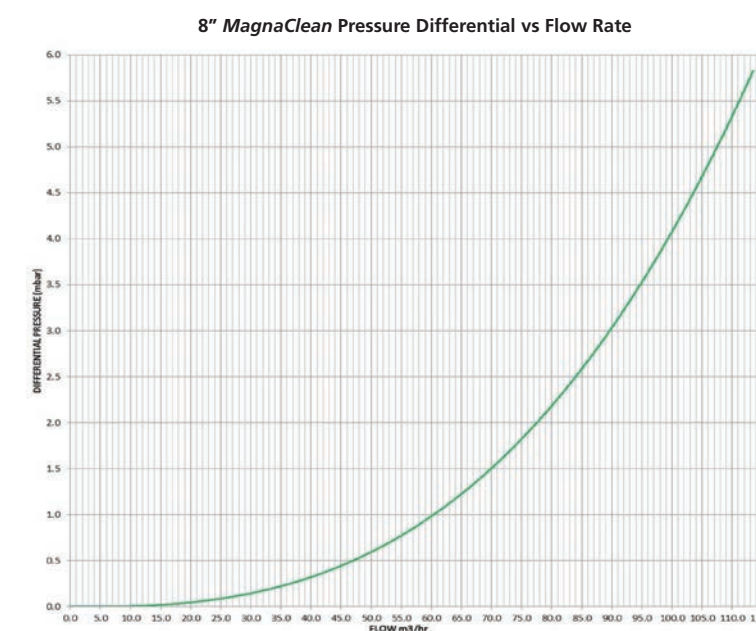
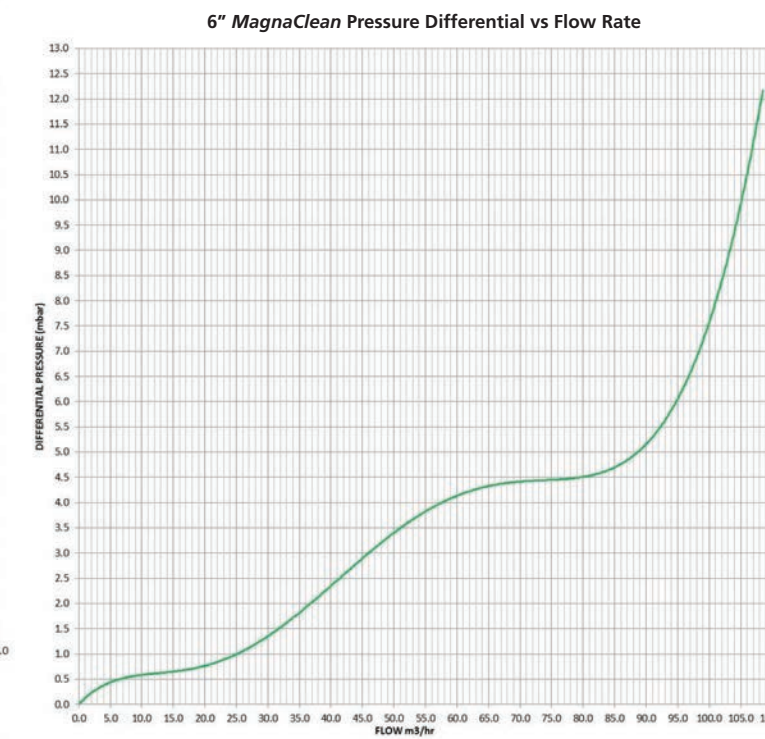
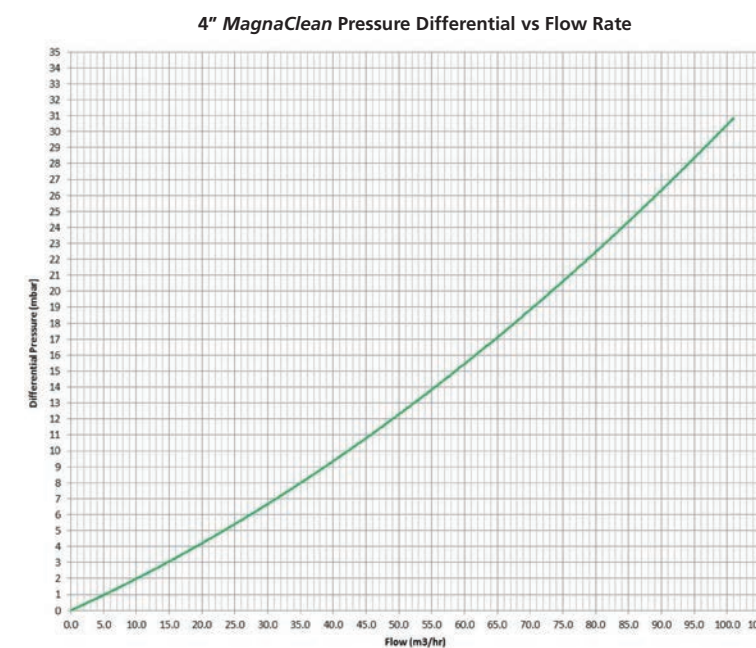
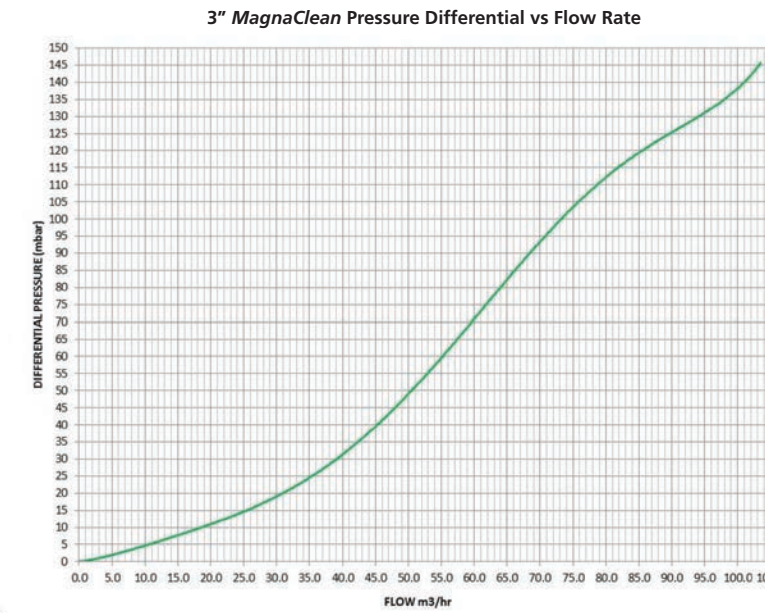
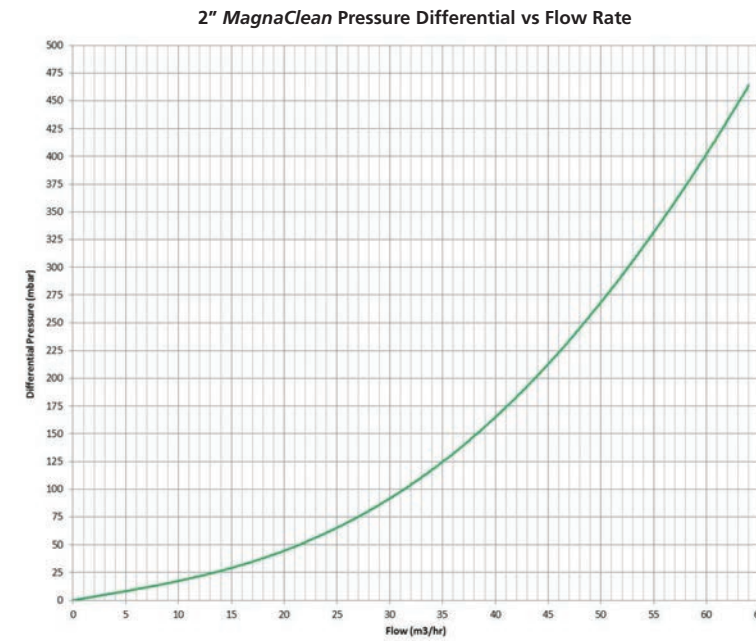

Measurements table

ADEY product code	Description	Filter diameter (mm)	Inlet size (mm)	No. of magnetic rods	Measurement (mm)												
					A	B	ØC	ØD	ØE	F	G	H1	H2	J	ØK	L	M
CP1-03-01123	2" filter	160	50	5	262	18	245	165	60	125	51	291	253	-9.5	160	18	4
CP1-03-01124	3" filter	210	80	6	330	15	295	200	92	160	60	331	278	2.5	210	18	8
CP1-03-01125	4" filter	216	100	7	360	15	299	220	113	180	72	347	303	15.5	216	18	8
CP1-03-01126	6" filter	324	150	9	470	18	430	285	164	240	73	446	333	2	324	22	8
CP1-03-02147	8" filter	324	200	9	538	19	430	340	222	295	88	448	350	35	324	22	12

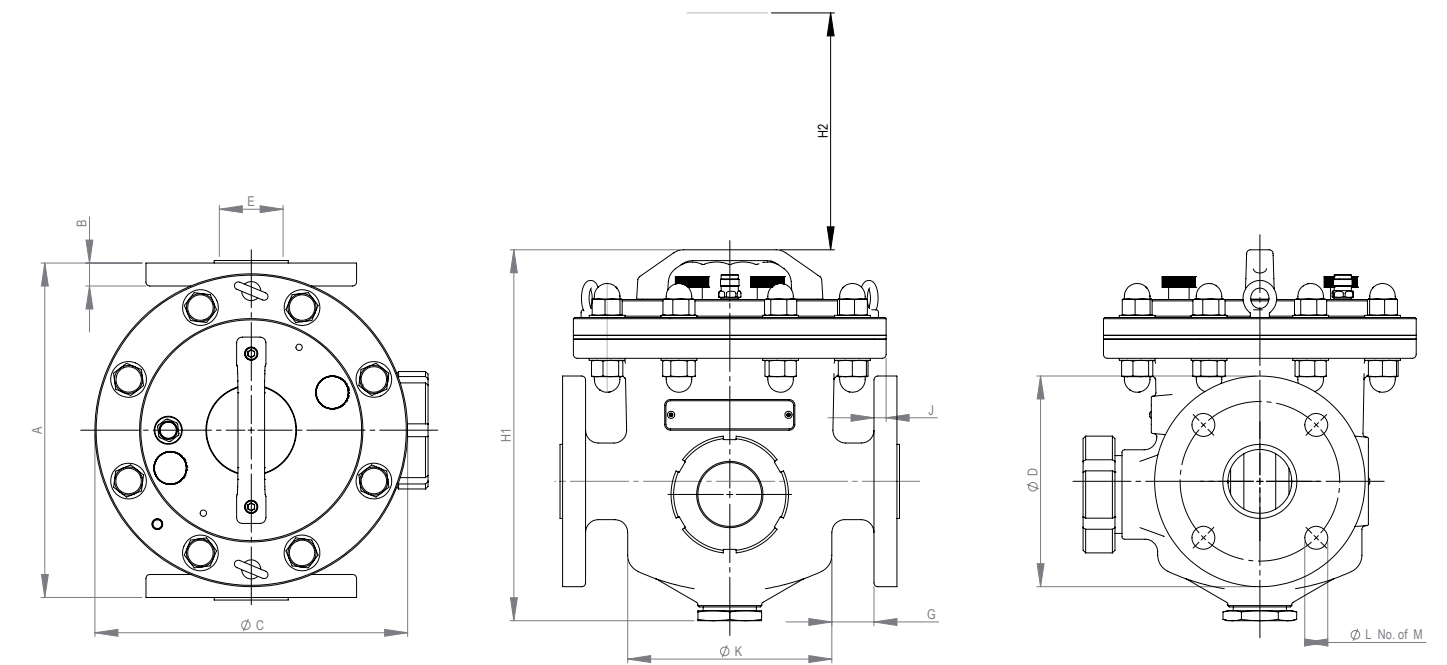

Step by step guide to installation

NOTE: When handling the magnets, care should be taken at all times to ensure they are not placed near another metallic/magnetic source. It is also important to keep the magnets dry at all times. If the magnet plate is removed ensure water does not spill inside the magnet pockets. Ensure all O-rings are seated correctly in the grooves above each magnet pocket before magnet plate is re-inserted.

Follow the illustrations and measurements for easy installation of *MagnaClean Commercial*.

There are four key steps to successful installation:

Step 1

Use the measurements table to identify the correct length of pipework to be cut-out, allowing for your isolation valves (refer to measurement 'A'). On the primary circuit on the return to the boiler is recommended. Give consideration to the area above *MagnaClean* to access and remove the magnets easily during servicing. Refer to dimension 'H2' on measurement table shown.

Step 2

Install the isolation valves and connect the two PN16 flanges to the isolation valves using suitable gaskets.

Step 3

Install *MagnaClean* ensuring that all fittings are aligned correctly and secure. Install a fixed drainage pipe and drain valve to the 1/4" drain point at the base of the unit (remove the drain plug first). Alternatively, remove the drain plug and connect to a drain hose when servicing.

Step 4

Having checked the installation, run the system for a period of time. Ensure the isolation valves are fully open and there are no leaks. If, on installation, you remove the magnet plate, before replacing, ensure the magnets and magnet pockets are moisture free by drying them with a soft absorbent cloth. Once completely dry, replace the magnet plate and tighten the black retaining knobs – Hand tighten only.

